

# Data Sheet

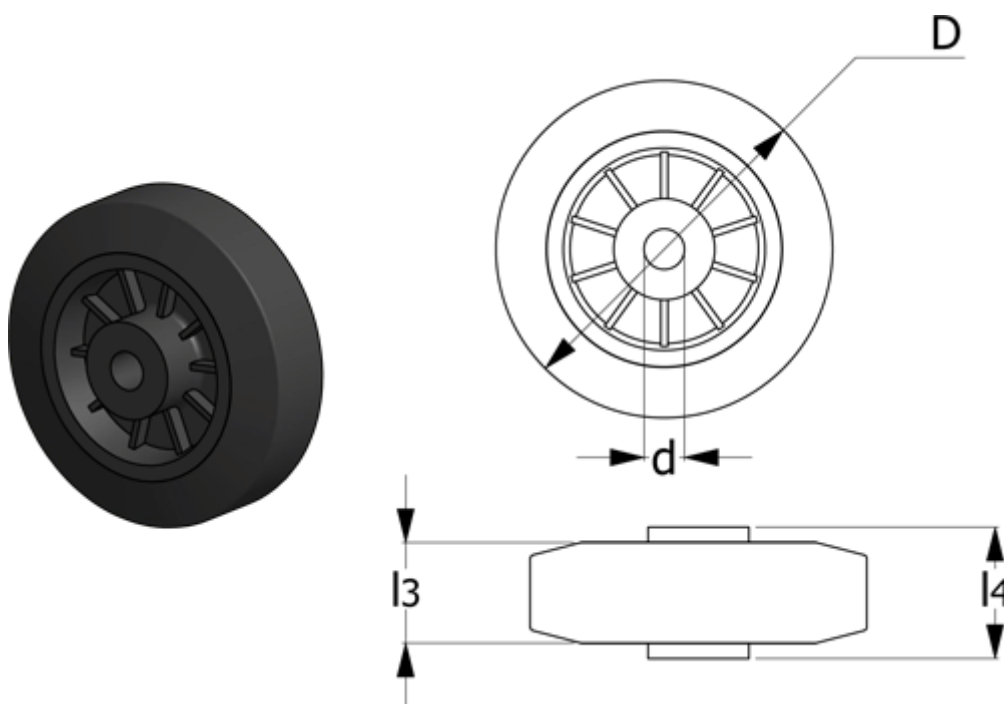

Article number: 2314449516  
Description: E+G rubber wheel 449516  
RE.E2-150-RBL loose wheel

## Measures



Code = 449516  
d = 15  
D = 150  
Dynamic load (N) = 1300  
g = 610  
l3 = 40  
l4 = 44  
Max static load (N) = 2750

Rolling resistance (N) = 1000  
Type = RE.E2-150-RBL